

NEWSLETTER

OUR TOP PICKS

- **GOOD PRACTICES FROM THE BASQUE COUNTRY**

Leartribai Fundazioa (lead partner) and Ente Vasco de la Energia hosted the first on-site meetings and study visits in Pais Vasco, Bilbao, during 13 - 15 June 2023.

There were three days full of energy, in which the members of the consortium were happy to meet for the first time in person to discuss subjects imperatively necessary for project management.

Partners had the opportunity to discover and learn about some of the strategic initiatives for the energy transition of the Basque Country, such as the Ispaster District heating projects, the Ekiola Lea-Artibai cooperative, and the BIMEP platform located in Mutriku.

All insights from the study visits are presented in the section "Good practices" in this newsletter.



CHARACTERISTICS



SlreENERGY project aims to improve regional and national policies by increasing the share of energy from renewable sources in rural areas to: better inform local consumers and empower self-consumers to generate - store - consume - sell renewable electricity without facing disproportionate burdens.

The project consortium wants to continue the Interreg Europe mission to build our common objective: be climate-neutral by 2050 (an objective arising from the European Green Deal)!

The project wants to offer local communities hands-on experiences in developing specific strategies to improve the acceptance and deployment of renewable energy, thus unlocking the potential in rural areas.

Project sub-objectives:

- To integrate renewable energy strategies into local, regional, and national economic development strategies to reflect local potential and needs;
- To integrate renewable energy within larger supply chains in rural economies, such as agriculture, forestry, traditional manufacturing, and green tourism;
- Local social acceptance by ensuring clear benefits of using renewable energy as the low-carbon alternative energy to local communities and engaging them in the design, financing, or management process;
- To increase the involvement of energy consumers as active players in the development of new renewable energy sources;
- To promote synergic dynamics for the generation of renewable energy projects, taking into account the natural resources of the rural area and all the agents involved, and the rest of the projects underway.



FIGURES

LEAD PARTNER

LEARTIBAI FOUNDATION



Local entity dedicated to economic development. Among other areas, they promote the transition of Pais Vasco rural territories towards self-sufficient energy and decarbonization.

CONTACT

JOINS FORCES WITH:



BASQUE ENERGY AGENCY

Ente Vasco de la Energía, proposes the Basque Government's energy strategies based on its technical knowledge.



ENERGIKONTOR SYD

ENERGIKONTOR SYD

Supports and facilitates improvements in EE and increasing the supply of RES through initiatives and activities towards private and public operators.

RAPIV

REGIONAL AGENCY FOR ENTREPRENEURSHIP AND INNOVATIONS-VARNA (RAPIV)

Carries out activities for the public benefit and stimulates the regional economy through the development of entrepreneurship and innovations.

IN THIS TIMEFRAME

01.03.2023

31.05.2027



heart of Poland

MARSHAL'S OFFICE OF THE MAZOVIAN VOIVODESHIP

Implements tasks connected with public education, healthcare, environmental protection and modernization of rural areas.

ADR

Agentia pentru Dezvoltare Regională
N O R D - E S T

NORTH-EAST REGIONAL DEVELOPMENT AGENCY

Develops and promotes strategies, attracts resources. It provides services to stimulate sustainable economic growth, partnerships, and entrepreneurship.



APE SA

ASSOCIATION FOR ENVIRONMENT AND SAFETY IN AQUITAIN (APESA)

develops technological solutions and innovative methodologies, events and training enabling social-economic players to integrate sustainable development into their strategy.

HAVING A BUDGET OF

TOTAL
1,424,100
EUR



TERMINOLOGY

The subject of the SIREENERGY project involves day to day use of technical terms from fields of renewable energy sources, energy efficiency, NZEB, or energy engineering. For this reason, we want to facilitate our readers an easy understanding of the texts addressed in our newsletter or the news presented on the project web page.



**Interreg
Europe**



Co-funded by
the European Union

SIREENERGY

SIREENERGY

**SOCIAL INNOVATION IN
RENEWABLE ENERGIES**

LC - LOCAL COMMUNITIES

GROUP THAT IS ORGANIZED AROUND COMMON VALUES AND IS ATTRIBUTED WITH SOCIAL COHESION WITHIN A SHARED GEOGRAPHICAL LOCATION, GENERALLY IN SOCIAL UNITS LARGER THAN A HOUSEHOLD.

NIMBY - NOT IN MY BACK YARD

CHARACTERIZATION OF OPPOSITION BY RESIDENTS TO PROPOSED DEVELOPMENTS IN THEIR LOCAL AREA, AS WELL AS SUPPORT FOR STRICT LAND USE REGULATIONS.

REC - RENEWABLE ENERGY COMMUNITIES

ASSOCIATION THAT PRODUCES AND SHARES RENEWABLE ENERGY, GENERATING AND MANAGING COST-EFFECTIVE GREEN ENERGY AUTONOMOUSLY, REDUCING CO2 EMISSIONS AND ENERGY WASTE.

RES - RENEWABLE ENERGY SOURCES

ENERGY DERIVED FROM NATURAL SOURCES THAT ARE REPLENISHED AT A HIGHER RATE THAN THEY ARE CONSUMED.

ACCEPTANCE

ATTITUDE OF THE LOCAL POPULATION OF A GIVEN TERRITORY TO ACCEPT THE PRESENCE, INSTALLATION OR EXPANSION OF PLANTS, PROJECTS AND PROCESSES FOR THE PRODUCTION OF ENERGY FROM RENEWABLE SOURCES (RES) SUCH AS GEOTHERMAL, SUN, WIND AND BIOMASS.

PROSUMER

INDIVIDUAL WHO USE A SMALL-SCALE PLANT TO PRODUCE AND CONSUME ENERGY FROM RENEWABLE SOURCES.

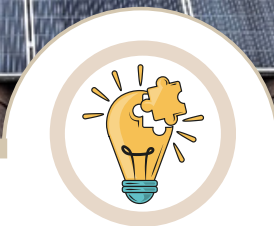

GOOD PRACTICES

DISTRICT HEATING - ISPASTER: CITIZENS AND MUNICIPALITY INVOLVEMENT

Ispaster is a small village (22 square kilometers) located in Euskadi, in the North of Spain, with 740 inhabitants. Their main goal is to be autonomous and to have an isolated energy island based 100% on RES.

Ispaster has 1,000 square meters of roofs suitable for solar installations and the possibility of obtaining 1,200 tons per year of residual forest biomass. Based on this potential, they have opted for renewable energies to be self-sufficient in energy and achieve a stable price in consumption. Thus, supplying hot water, heating, and electricity in public buildings comes from its network. Currently, the percentage of local renewable energy exceeds 75% in all consumption of the microgrid.



BOILER



HEATING SYSTEM



INSIDE
VENTILATION



WOOD CHIPS



3 PHASES



The ring-shaped alignment of Ispaster's heating project was built in three phases:

Phase 1 - school with biomass. The project started by providing thermal energy to the municipal school;

Phase 2.1 - a heating network which provides domestic hot water and heating for several public buildings;

Phase 2.2 - photovoltaic panels were installed, with the scope to increase energy efficiency;

Phase 3 - extending the network with heating, hot water, and electricity from biomass boilers (local wood chips) and solar energy.

All of this provides electricity to 10 public consumption points and thermal energy for up to 13 points (including a building apartment of 10 private houses).

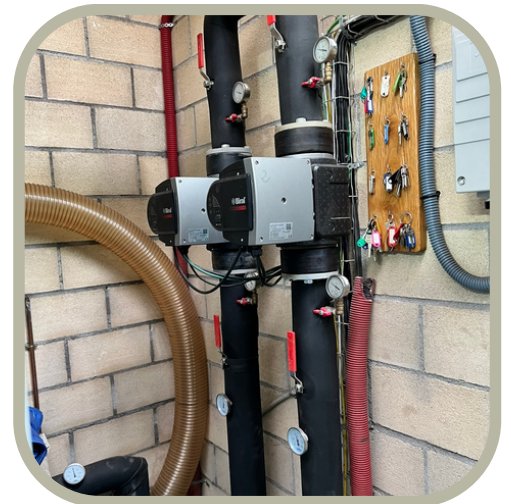

CONTACT DETAILS:

MAITANE ZIRION

ENERGY MANAGEMENT
TECHNICIAN AT THE
ISPASTER CITY COUNCIL

ISPASTER.ENERGIA@GMAIL.COM





GOOD PRACTICES

THE POWER OF LOCAL ENERGY COMMUNITIES - EKIOLA

Ekiola Energy Promotions is an association between Krean, a cooperative that creates infrastructures and spaces (architecture and industry), and Basque Energy Agency (Ente Vasco de la Energia) and is a promoter of non-profit citizen consumer cooperatives that build photovoltaic power plants (1 - 5 MW) to fulfill cooperative members' consumption.

Thus, the values of the economic structure of the Basque Country are aligned with Ekiola and allow the involvement of a higher number of neighbors. In this matter, in the future, the photovoltaic solar park, planned to be located on public land near the DWTP (Drinking Water Treatment Station) of Iparragirre, will start up and will allow its supply with clean energy generated.



TECHNICAL
PROJECT
DEVELOPMENT



AZPEITIA: 570
CITIZENS SIGNED-
UP

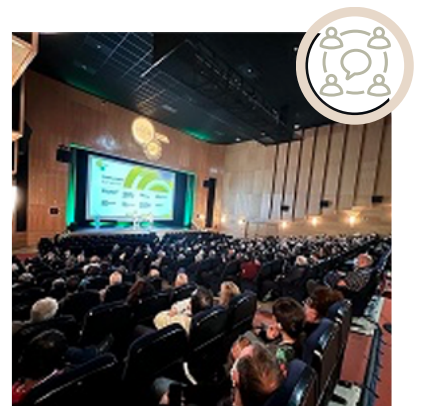

SERVICES
COOPERATIVE



ARRAIA-MAEZTU:
60 CITIZENS
SIGNED-UP

3 PHASES



There are three phases to empower citizens to generate and manage renewable energy for consumption and to implement such projects:

Phase 1- Action protocol between the City Council and Regional Government;

Phase 2- Set up a Services Cooperative and Promotion where are developed technical and feasibility studies, analysis, and licenses and authorizations are approved. Promotion and socialization are the main steps in this phase because it enrolls public institutions and local associations. Thus local energy community is created;

Phase 3- Turnkey constructions and consumption become cooperative. The management is between Ekiola and energy traders, and the maintenance for the PV plant is preventive and corrective.



CONTACT DETAILS:

OSCAR PUCHE

SENIOR INDUSTRIAL
ENGINEER, ENERGY
TECHNIQUES

OPUCHE@EVE.EUS





GOOD PRACTICES

BIMEP - MUTRIKU: ACCEPTANCE OF THE COMMUNITY

The wave energy plant at Mutriku can host trials of new concepts of air turbine, control strategy, and auxiliary equipment for OWC devices (Oscillating Water Column), the most updated technology currently available for harnessing sea waves.

Built into the breakwater at the harbor in Mutriku, the plant has a total capacity of 296kW and has been supplying electricity to the grid since 2011.

Biscay Marine Energy Platform is an infrastructure for testing prototypes of ocean energy collectors and auxiliary equipment on the open sea, located off-coast at Armintza. BiMEP provides technology developers with a site with suitable wave and wind resources for testing the technical and economic viability of different concept designs, offering security before advancing to the full-scale commercial phase.



ENTRANCE
TURBINE ROOM



INSIDE DAM



VOITH TURBINE



ROTOR VOITH
TURBINE



The plant at Mutriku consists of 16 chambers, each one with its corresponding turbine-alternator group, integrated into the seawall at Mutriku.

The air passing through the turbine causes it to move, which turns the alternator, generating electric energy. When the wave recedes, the air is suctioned in and passes through the turbine, moving the alternator and producing electricity.

The total power installed is 296 kW, and electric production is around 400 000 kWh/year, the equivalent of the annual electric consumption of 100 families.

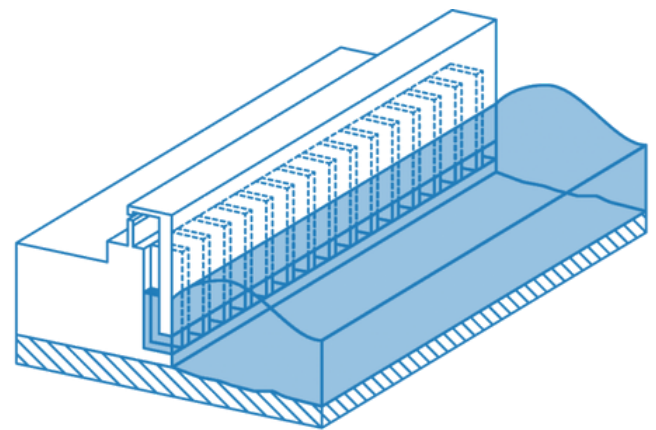

CONTACT DETAILS:

JON LEKUBE

BISCAY MARINE ENERGY
PLATFORM (BIMEP)

JLEKUBE@BIMEP.COM

FIRST ENCOUNTER BETWEEN REGIONAL STAKEHOLDERS AND SIRENERGY

NORTH-EAST REGION
OF ROMANIA

Wednesday, July 19th | 2023



HOST

North-East
Regional
Development
Agency



TYPE

On-line
meeting



17

ATTENDEES

I – situația actuala în RO și UE

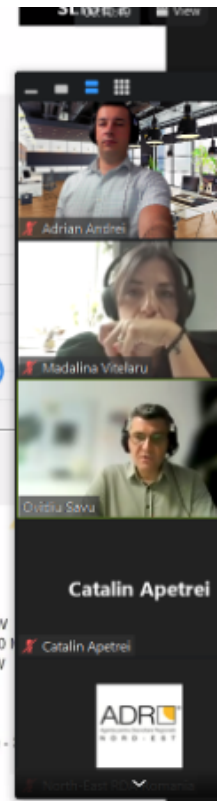
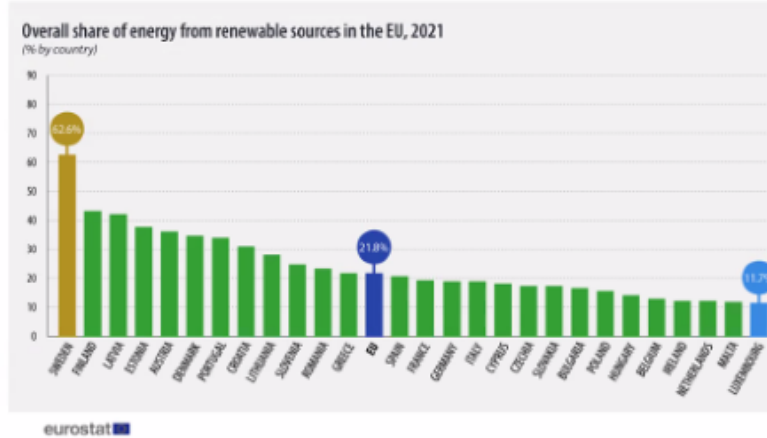
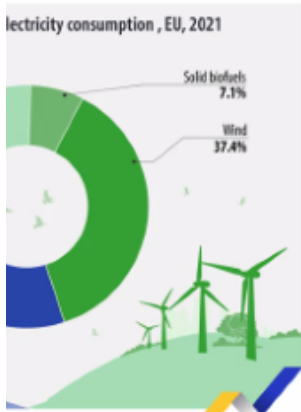

The first encounter between North-East RDA's regional stakeholders and SireENERGY occurred on June 19 via the Zoom platform.

The online meeting hosted 17 people, where representatives of the North-East RDA presented:

- the preamble of the current situation in Romania, the region, and in the EU related to RES;
- SireENERGY's objectives, purpose, partnership, and figures;
- advantages and challenges in rural areas;
- stakeholder's involvement in this project.

Overall, the persons who most benefit from Interreg Europe projects are the persons joining the stakeholder groups in the partnership.

Considering all this, the North-East Regional Development Agency took along local public authorities, county councils (with rural development as a priority), and companies (working in the renewable energy sources field).

After a free discussion in which everyone pitched their idea, several opportunities lined up, and we can work on them at the regional level. We agreed on the development of two primary X-rays in the region:

- the existing situation, forecasts, and expectations, from buildings to large energy consumers;
- RES – certified biomass, PV with energy storage.

Also, there was taken into consideration the implementation of several ideas related to awareness among students, pupils, and residents in rural and urban areas, promoting local innovation projects on RES.

In conclusion, the meeting brought a mutual understanding, fruitful collaboration between the entities present and ad-hoc brainstorming that turned into great ideas built on actual needs.



INTERVIEWS

ROBERT HEDMAN. ENERGY STRATEGIST, SUSTAINABLE
COMMUNITY PLANNING, REGION BLEKINGE



REGION
BLEKINGE



"I THINK IT IS
IMPORTANT TO
VISUALIZE THE
TRUE COST AND
IMPACT FROM
THE USE OF
FOSSIL FUELS. IF
YOU LIFT THE
DISADVANTAGES
WITH FOSSILS IT
WILL BE EASIER
TO ACCEPT THE
DRAWBACK WITH
RENEWABLE
ENERGY
SOURCES."

FROM SERVING THE SWEDISH AIR FORCE TO SERVING THE SUSTAINABLE ENERGY COMMUNITIES

WRITTEN BY GEORGIANA NEDELEA

We had the pleasure of having a few interesting discussions during the SireENERGY study visit, and we wanted to **present you, Robert**, to our readers and share parts of your knowledge and experience in the energy sector. Enjoy your reading!

Q: Let's start by asking you about your drive to be one of the stakeholders for Energikontor SYD in this project and what this project should accomplish for your organization.

A: The advantage of an Interreg Europe project is the possibility to see and learn from other regions. Also, to learn about the different prerequisites and possibilities that various regions have.

**Q: DO YOU WANT TO BE MORE INVOLVED IN THE
PROJECT IN THE FUTURE?**

A: ABSOLUTELY!



Q: We found out that you served in the Swedish Air Force. That is quite interesting and different from your job today. Could you tell us a bit more about that? And where did this paradigm shift come from, sergeant to energy strategist? What do you bring from your previous organization?

A: In the air force, I did not work with energy at all, and my job had little connections with civil society, so this is very different! One thing I learned in the Air Force that I bring with me is the power of cooperation and working together.

Q: WHERE DOES YOUR PASSION AND INSPIRATION FOR GREEN ENERGY COME FROM?

A: I think I belong to the Agenda 21 generation and had an interest in climate and society for many years. At university, I studied environmental science, so you can say I finally work with things I was educated for!

Q: What can you tell us about the study visit? What were the most relevant notions for you? What was the most interesting good practice? What are you left with after this experience?

A: The work done in Ispaster with many projects did impress me. I was a little bit fascinated that bio-fueled district heating was not used to its maximum capacity. There seemed to be a lot of wood in the region. It was also a reminder of the challenges of removing fossil gas from the system. Finally, I learned that there are many possibilities and challenges with wave power.

DEAR READERS,
WE HOPE YOU ENJOYED DISCOVERING ROBERT AS MUCH AS WE DID IN THE BASQUE COUNTRY.

WE HOPE TO MEET HIM IN THE SWEDISH STUDY VISIT AGAIN!
UNTIL THEN, STAY WITH US

NEXT ON
SECOND SEMESTER



UPCOMING

EVENTS

STAKEHOLDER MEETINGS



2ND SEMESTER

**HOST: EACH PROJECT
PARTNER**

ON-SITE INTERREGIONAL MEETING



FEBRUARY

**HOST: ENERGIKONTOR SYD
COUNTRY: SWEDEN**

KEEP ON IMPLEMENTING ACTIVITIES

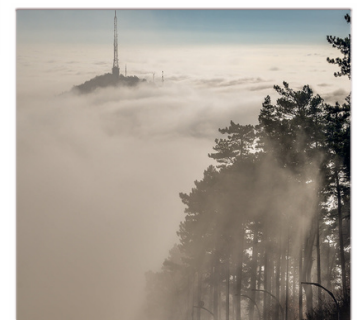

2ND SEMESTER

**VALIDATING GOOD
PRACTICES
HOLISTIC DIAGNOSIS
AND MANY OTHERS**

SUBSCRIBE

TO OUR NEWSLETTER



HERE!

CONTACT US!



LEAD PARTNER

Leire Arrizabalaga Aranbarri

ADR ®

Agencia pentru Dezvoltare Regională

N O R D - E S T

COMMUNICATION MANAGER

Georgiana Gabriela Nedelea

FOLLOW OUR SOCIAL MEDIA

